



Technical Training Guide



Safety Precautions



High Voltage Electrocution Hazard

Hazardous voltage can shock, burn, cause serious injury and or death. To reduce the risk of electrocution and or electric shock hazards:

- Only qualified technicians should install the vessel
- Replace damaged wiring immediately
- Insure vessel is properly grounded and bonded
- Device **MUST** be G.F.C.I. protected

Ultraviolet Radiation

- Disconnect power before replacing lamp
- UV LIGHT PRODUCED BY THIS UNIT IS HARMFUL TO THE EYES AND MAY CAUSE BLINDNESS. DO NOT LOOK DIRECTLY AT A LIT BULB!

Table of Contents

How it Works

1. Talking Points
2. Advanced Oxidation Process

Pg. 4-8

5-6

7-8

How to Guide

1. Install HydraPure
2. Wire HydraPure
3. Pool Preparation
4. HydraPure Orientation and Operation

Pg. 9-17

10-11

12-14

15

16-17

Maintenance Guide

1. Clean the Quartz Tube
2. Replace UV Lamp and O3 Lamp
3. Winterize HydraPure

Pg. 18-28

19-22

23-27

28

Troubleshooting Guide

1. Power and Flow LED's
2. Installing pressure switch
3. UV Bulb Life LED
4. Ozone Bulb Life LED

Pg. 29-41

30-34

35

36-38

39-41

Parts Breakdown

1. Exploded View
2. Parts List

Pg. 42-45

43

44-45



HYDRAPURE
CLEAN WATER · SIMPLIFIED

How it Works



How it works: Talking Points

- Advanced Oxidation Process (AOP) combines UV and Ozone to create Hydroxyl Radicals.



- Works to purify water while reducing the amount of traditional or salt-generated chlorine by up to 80%.
- Safely inactivates 99.9% of microorganisms (up to 80 GPM) while using less chemicals.

How it works: Talking Points (cont.)

- Easy to install.
- Works well with variable speed pumps and easily handles required turnover flow rates up to 120 GPM.
- Weather does NOT influence the effectiveness.
- Safe, eco-friendly, energy efficient, & family friendly.
- Residential pools up to 40,000 gallons.

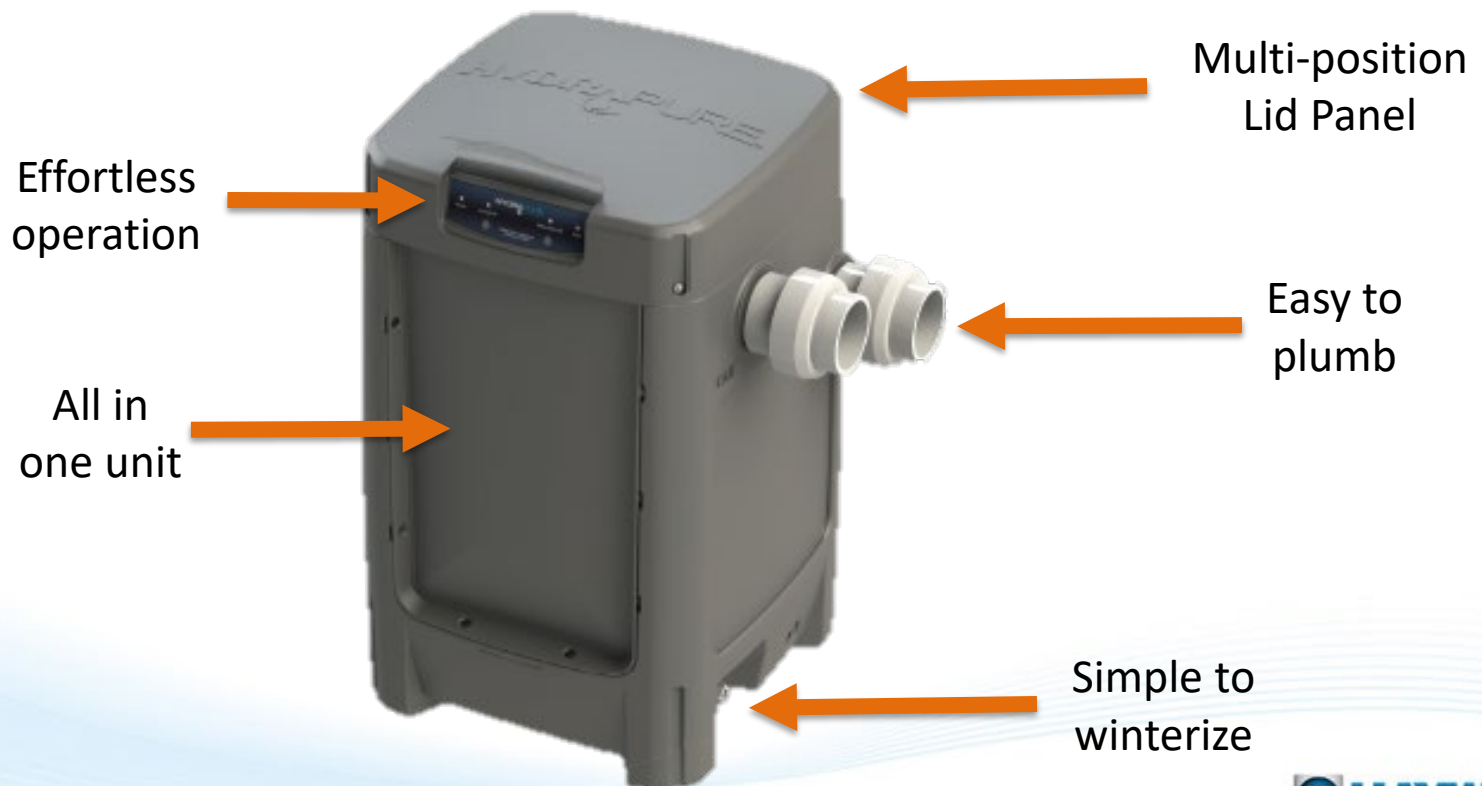

How it works:



Water flows into the inlet port of the HydraPure system. The wet chamber can handle up to 120 gpm, but is most effective up to 80 gpm.

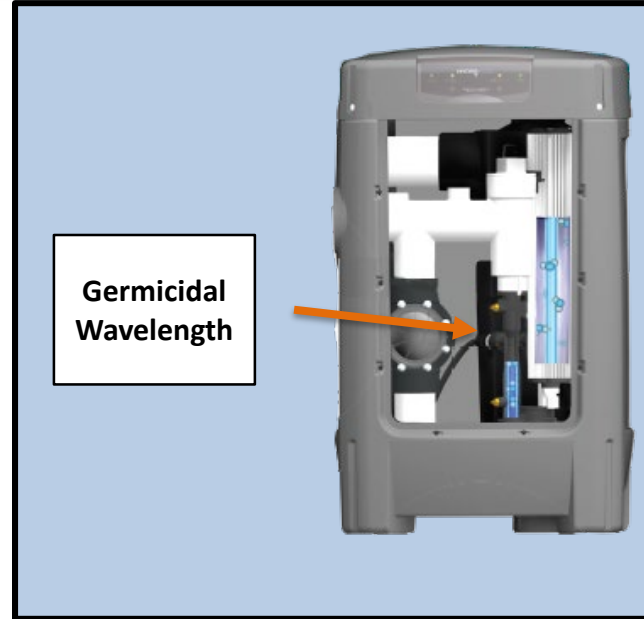

As water flows through the wet chamber, it is treated by a UV light wavelength emitting at 254nm to reduce a wide array of microorganisms.

*nm refers to nanometers and is how ultraviolet light is measured

How it works: **AOP** (cont.)

ADVANCED OXIDATION PROCESS

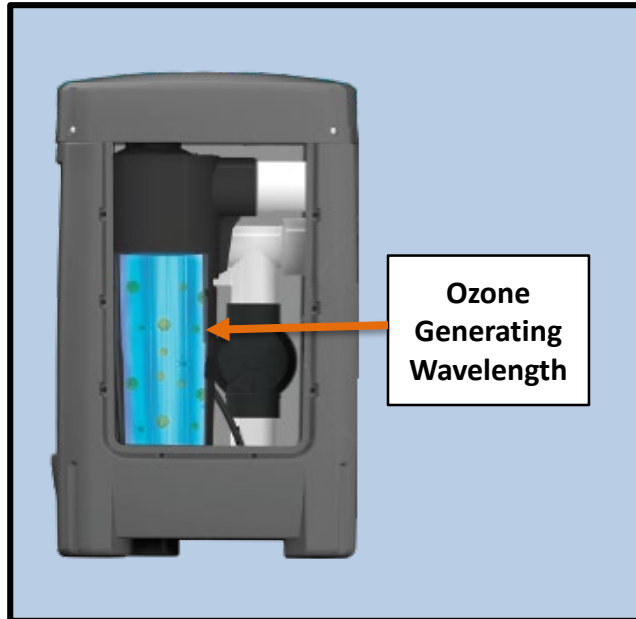

As water continues to flow through the wet chamber it will interact with an Ozone bulb emitting a wavelength of 185nm.

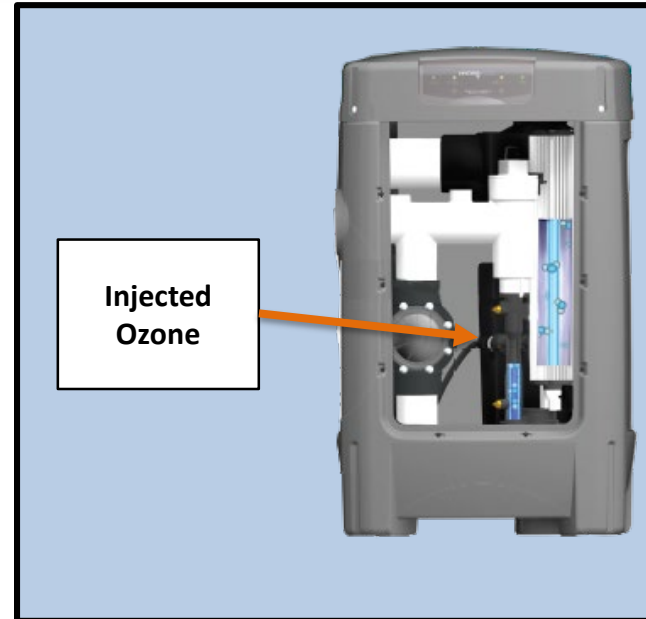

The Ozone is injected into the water stream using a venturi. The Ozone and UV combined creates the Advanced Oxidation Process or AOP.



HYDRAPURE
CLEAN WATER · SIMPLIFIED

How to Guide



How to: Install HydraPure

- Power to filter pump must be off before starting the installation.
- Install HydraPure Vessel on a level concrete slab or other rigid base.
- HydraPure includes two 2 ½" unions. If dealing with 2" plumbing you must use 2" x 2 ½" reducer bushings (not included).
- HydraPure must be installed AFTER the filter and has a maximum operating pressure of 50psi.
- HydraPure should be installed after all equipment (pump, filter, heater) but prior to any chlorinators (salt cell, tablet feeder, liquid injection).

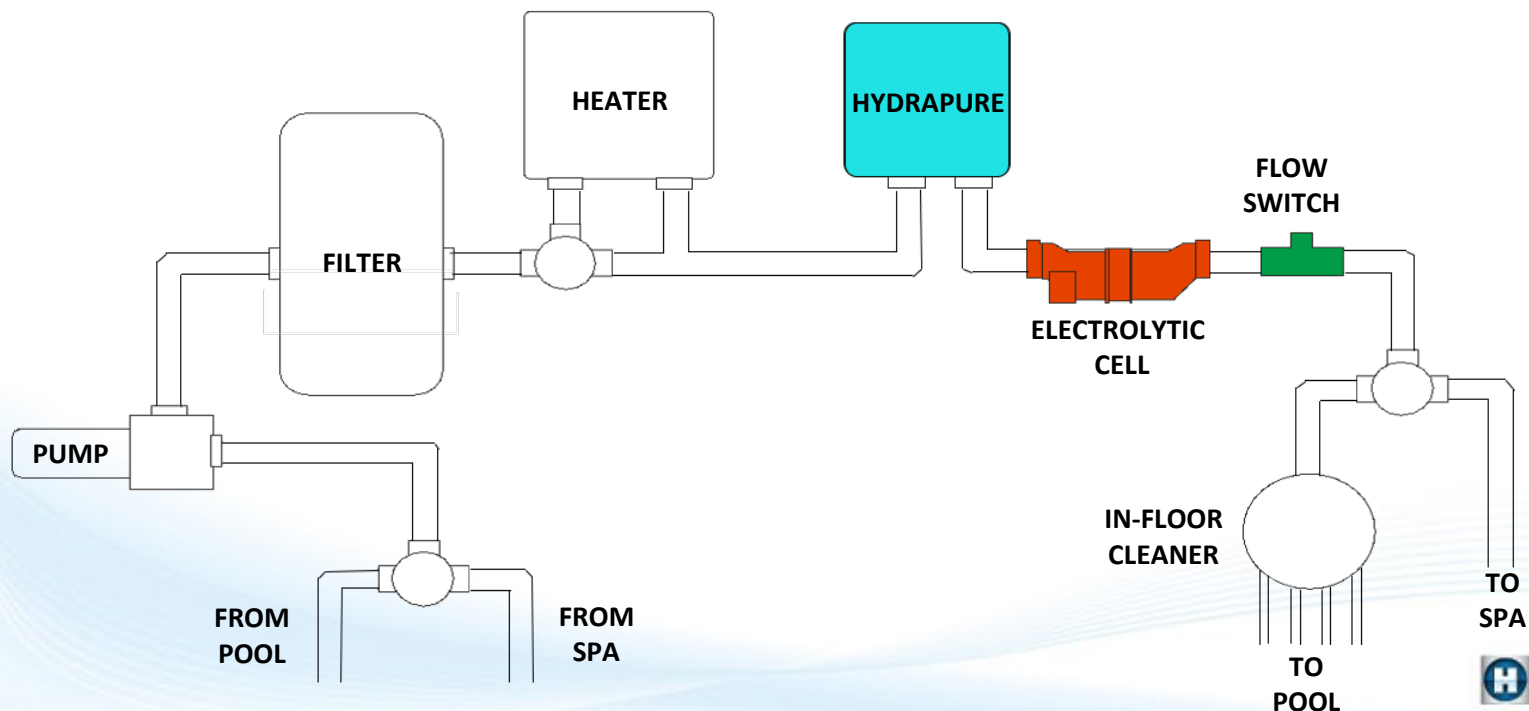

How to: Install HydraPure (cont.)

- HydraPure must be at least 10 feet from the pool.
- Do NOT overtighten the unions as this may cause them to break.
- HydraPure can operate between 20 gpm – 120 gpm without the need for an external bypass. However, anything over 80 gpm will decrease the performance of the vessel.
- Refer to table below for Head Loss Information.

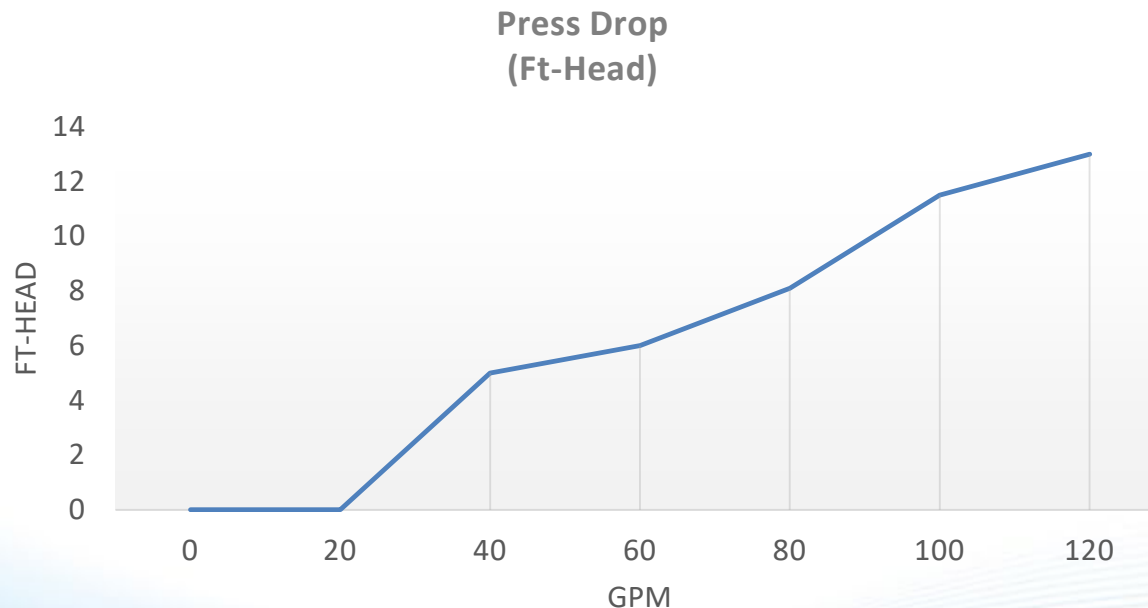

How to: Wire HydraPure

- Available in a corded or hardwired version.
- The corded version is rated for 120vac 50hz/60hz applications.
- The hardwired version is **voltage sensing** and can be installed on either 120vac or 240vac 50hz/60hz applications using ½" flexible conduit. **No conversion necessary.**
- Power consumption is 120watts; or 1.2amps for 120vac; 0.6amps for 240vac.
- HydraPure should be on it's own dedicated GFCI breaker when hardwired.
- HydraPure **MUST** be bonded using a #8 solid copper bond wire.
- Recommended to have on Load side of timer or on a relay.

Hardwired Version

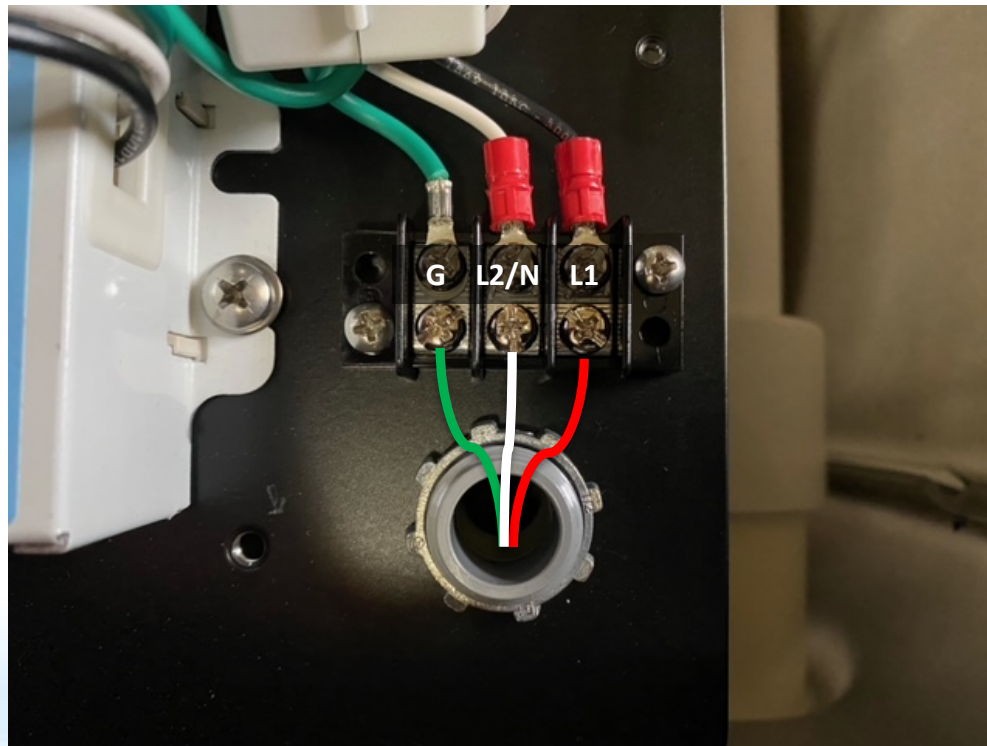

How to: Recommended for 230vac Applications

Siemens QF220
20 Amp 2 Pole 240vac GFCI



- ✓ *Plug in mounting style
- ✓ Class A - 20 amp GFCI protection
- ✓ UL listed at **5 milliamp** trip sensitivity
- ✓ 240vac two pole circuit breaker

Square D Homeline HOM220GFI
20 Amp 2 Pole 240vac GFCI



- ✓ *Plug in mounting style
- ✓ Class A - 20 amp GFCI protection
- ✓ UL listed at **6 milliamp** trip sensitivity
- ✓ 240vac two pole circuit breaker

*The use of these circuit breakers can help reduce the occurrence of nuisance tripping of the GFCI

How to: Recommended for 120vac Applications

Siemens QF115P
15 Amp 1 Pole 120vac GFCI

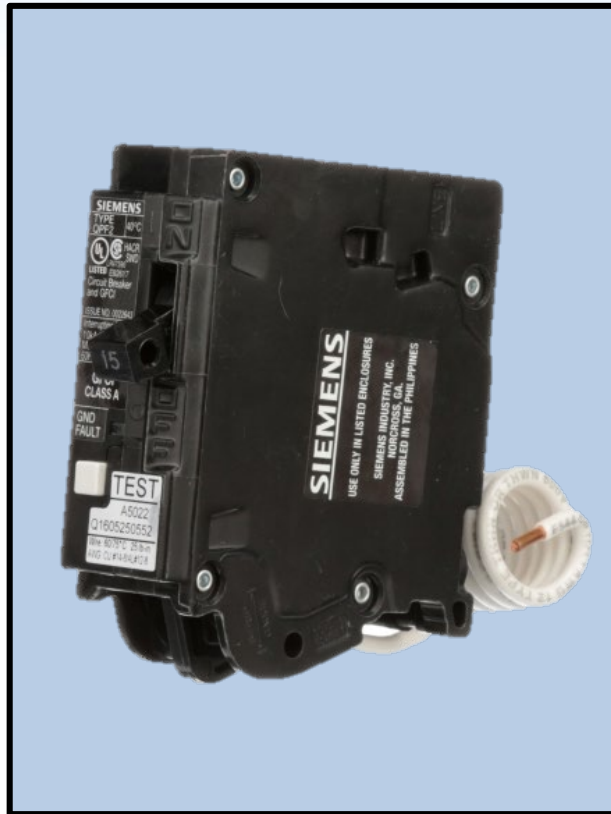

- ✓ *Plug in mounting style
- ✓ Class A - 15 amp GFCI protection
- ✓ UL listed at **5 milliamp** trip sensitivity
- ✓ 120vac single pole circuit breaker

Square D Homeline HOM115GFICP
15 Amp 1 Pole 120vac GFCI



- ✓ *Plug in mounting style
- ✓ Class A – 15 amp GFCI protection
- ✓ UL listed at **6 milliamp** trip sensitivity
- ✓ 120vac single pole circuit breaker

*The use of these circuit breakers can help reduce the occurrence of nuisance tripping of the GFCI

How to: Pool Preparation

- Start pump and verify there are no leaks.
- If opening the pool for the first time of the season, sanitize and balance the pool BEFORE operating HydraPure.
- If pool is already open, before operating the HydraPure, pool chemistry must be checked and properly balanced.

| Chemical | Ideal Levels |
|------------------|-------------------------------|
| Free Chlorine | .5 to 3.0 ppm |
| Cyanuric Acid | 30 to 50 ppm |
| pH | 7.2 to 7.8 |
| Total Alkalinity | 80 to 120 ppm |
| Calcium Hardness | 200 to 400 ppm |
| Iron | Less than 0.3 ppm (0.3mg/L) |
| Manganese | Less than 0.05 ppm (0.05mg/L) |

How to: HydraPure Lid Orientation

- Houses the LED Indicators.
- Designed to be able to be oriented toward each of the 4 sides of the unit.
- To adjust orientation remove the 4 screws securing the Lid cover.
- Lift the Lid cover and rotate to desired position and lower back on to the unit.
- Reinstall the 4 screws. Do not overtighten.



*Be aware that there is a delicate control ribbon cable under the lid. Take care when handling.

How to: HydraPure Operation

***When power is first applied to unit, the UV and Ozone indicators will light up red for a brief moment. This is normal operation and they should switch to green if operating correctly. The green hue of the POWER / FLOW LEDs ARE different from the UV / OZONE LEDs.**

Indicates power to the HydraPure Unit

Indicates UV bulb life status

Indicates Ozone bulb life status

Indicates water flow to the HydraPure unit

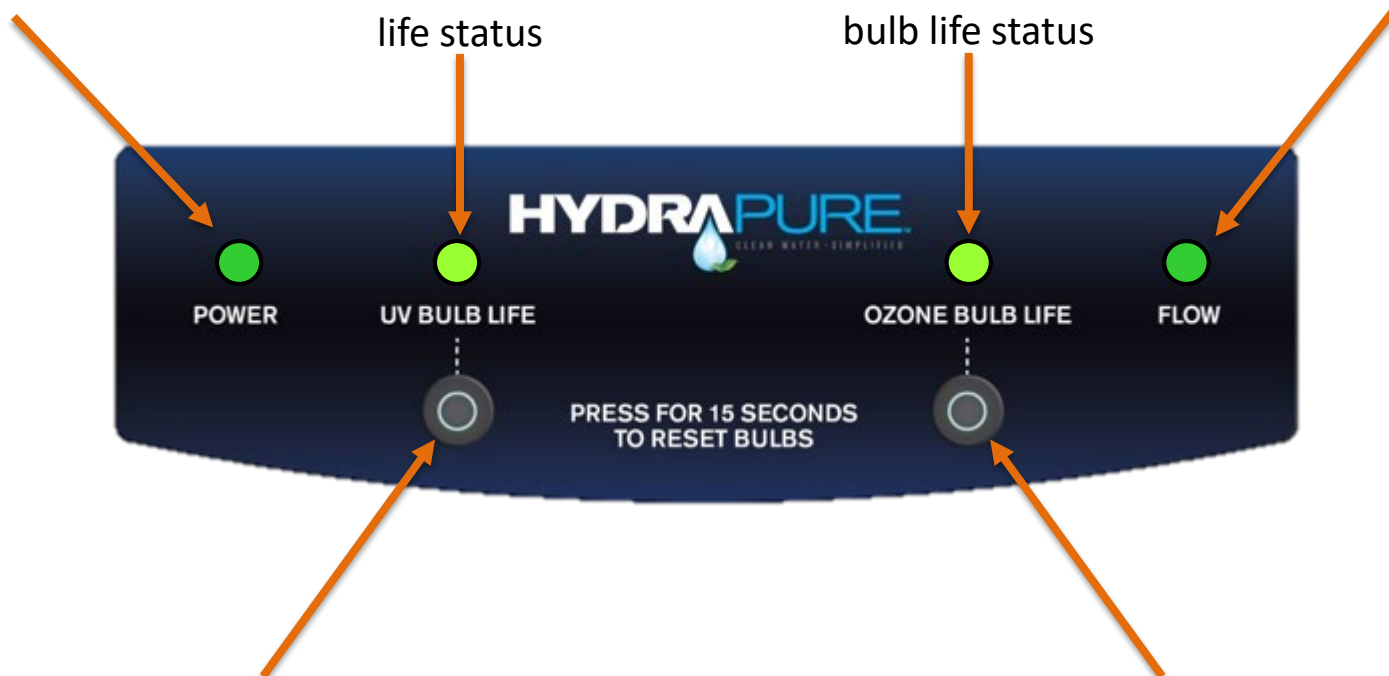

This button is only pressed after changing the UV bulb. Press and hold for 15 seconds while the unit is connected to power in order to reset the UV bulb life indicator.

This button is only pressed after changing the Ozone bulb. Press and hold for 15 seconds while the unit is connected to power in order to reset the Ozone bulb life indicator.



HYDRAPURE
CLEAN WATER · SIMPLIFIED

Maintenance Guide



Maintenance: Clean the Quartz Tube

The quartz tube requires cleaning every 12 months for optimum performance.

Step 1

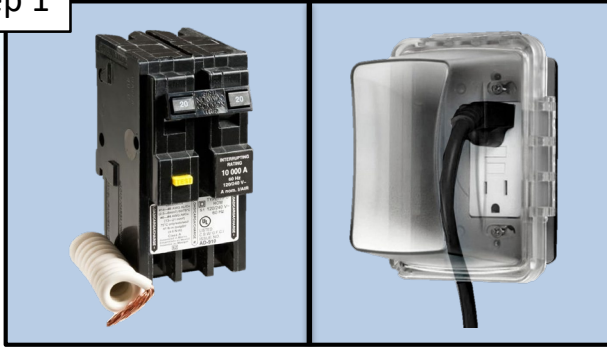

Turn off/unplug all power to the HydraPure and all other pool equipment. Allow unit to cool for 15 minutes before proceeding to the next step.

Step 2

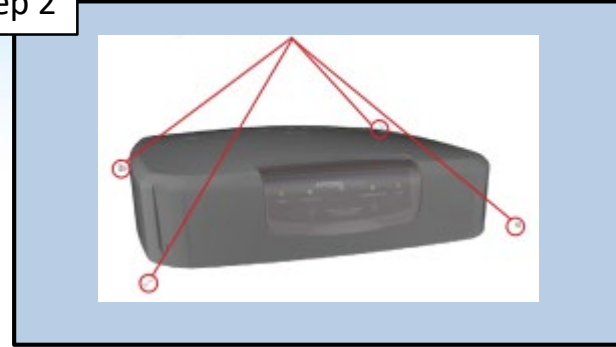

Remove the four (4) screws that secure the Lid cover. Use the provided strain relief to allow cover to hang to the side.

Step 3



Remove the one (1) screw that secures the electrical enclosure cover, remove the cover and set it to the side.

Step 4

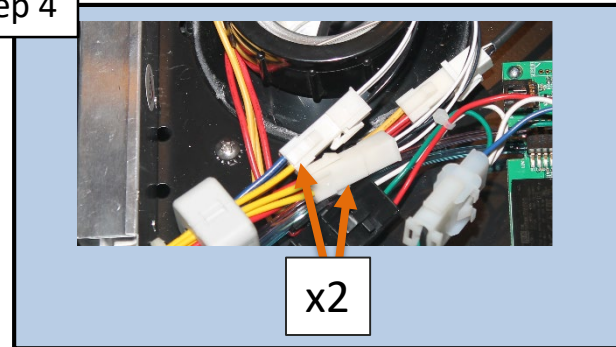

*Wearing protective rubber gloves and safety eyewear, disconnect the lamps by pressing the release tabs and gently pulling apart.

***Take care to not touch the glass part of the lamps as body oils will create hot spots and shorten bulb life.**

Maintenance: Clean the Quartz Tube (cont.)

Step 5



Remove the spring clip and carefully lift the lamp assembly from the quartz tube. Do not pull on lamp wires. Set aside in a safe place.

Step 6

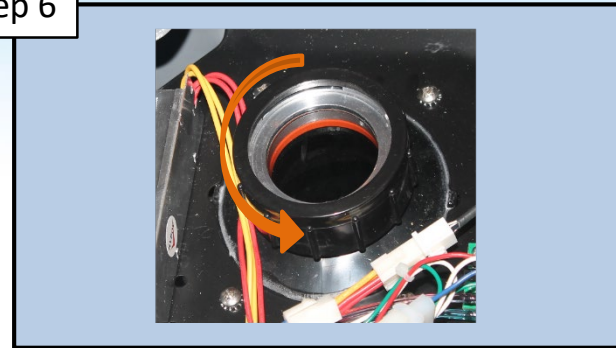

Remove the round sealing nut by turning it counter clockwise. Remove compression washer. Do not lose the black gasket.

Step 7

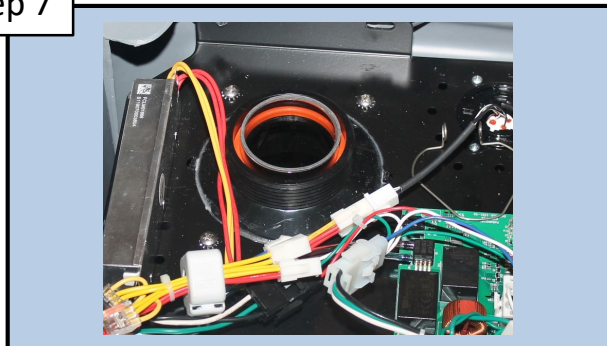

*Grip quartz tube with both thumbs inside and pull up. Once O-ring breaks free the tube should lift out easily.

Step 8



Wear proper PPE, use a shower cleaner, CLR type cleaner, or a solution of white vinegar and water to clean the outside of the quartz tube.

Maintenance: Clean the Quartz Tube (cont.)

Step 9



Clean the inside of the tube if necessary. Inspect the tube for cracks or chips. Verify the tube is completely dry and clear of residue prior to reassembly.

Step 10

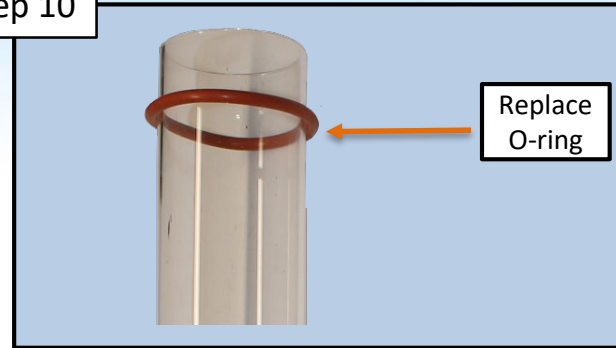

Replace O-ring with a new O-ring after cleaning the tube. Place the new O-ring 2" from top of quartz tube. **Do NOT** use lube or sealing agent on the O-ring.

Step 11



Gently lower tube into unit until O-ring contacts top of black sealing sleeve. Place compression washer onto the quartz tube and press down until O-ring moves into black sealing sleeve.

Step 12

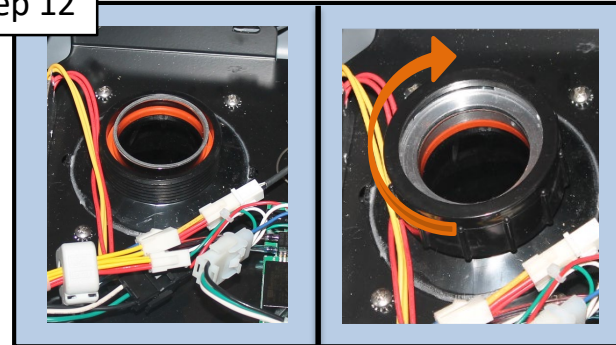

Lift compression washer to verify proper seating. Re-install washer and screw on the quartz sealing nut to hand tight plus $\frac{1}{2}$ a turn. Turn pump on and check for leaks.

Maintenance: Clean the Quartz Tube (cont.)

Step 13

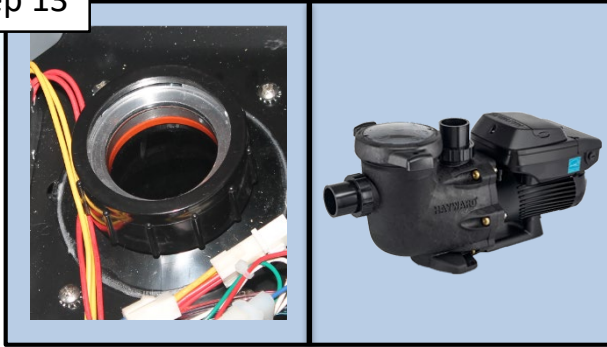

Turn on the filter pump and confirm there are no leaks then turn pump off.

Step 14

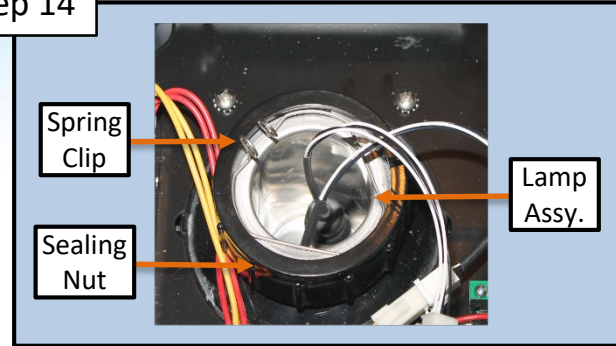

Carefully re-install lamp assembly, and spring clip.

Step 15

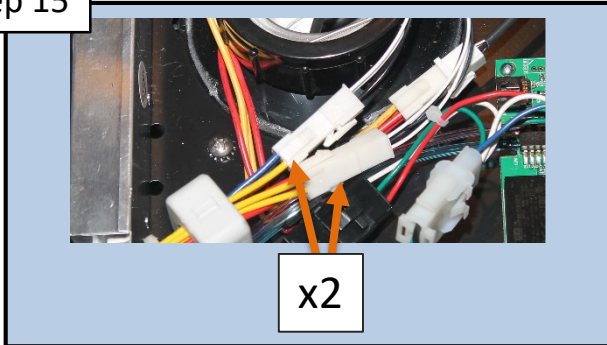

Re-connect both UV lamp wires to the UV Ballast.

Step 16

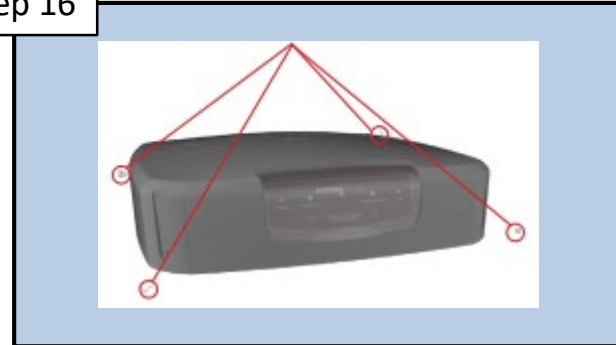

Re-install electrical cover and Lid cover and turn the pump back on.

Maintenance: Replace UV Lamps

Step 1

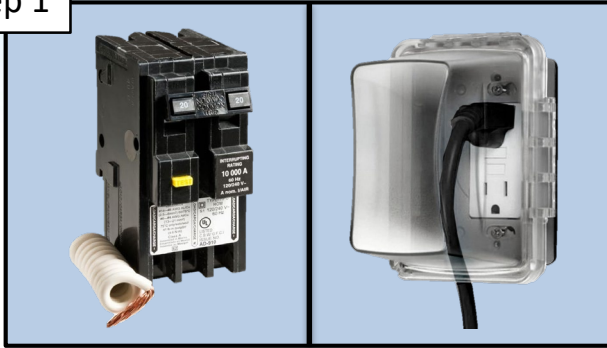

Turn off/unplug all power to the HydraPure and all other pool equipment. Allow unit to cool for 15 minutes before proceeding to the next step.

Step 2

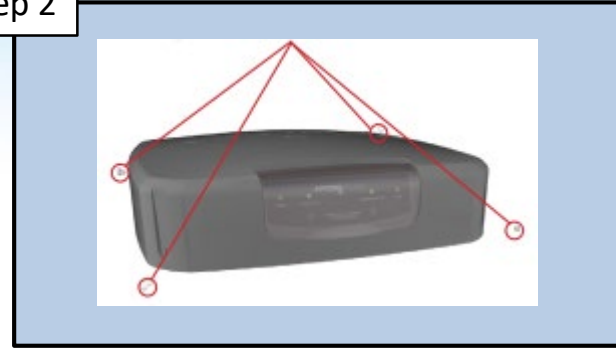

Remove the four (4) screws that secure the Lid cover. Use the provided strain relief to allow cover to hang to the side.

Step 3



Remove the one (1) screw that secures the electrical enclosure cover, remove the cover and set it to the side.

Step 4

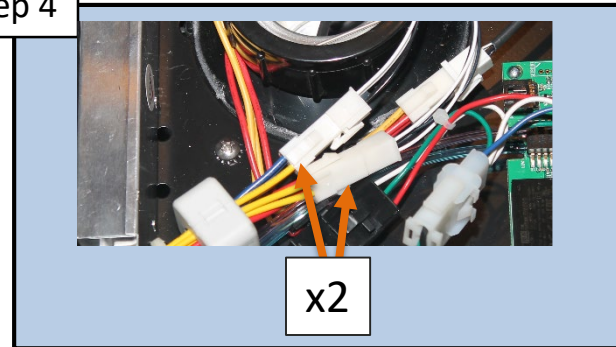

*Wearing protective rubber gloves and safety eyewear, disconnect the lamps by pressing the release tabs and gently pulling apart.

Maintenance: Replace UV Lamps (cont.)

Step 5



Remove the spring clip and carefully lift the lamp assembly from the quartz tube. Do not pull on lamp wires. Set aside in a safe place.

Step 6

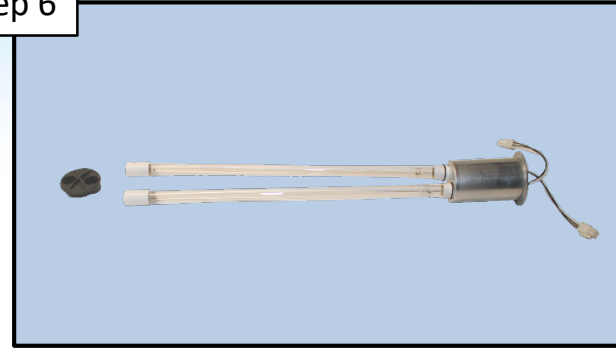

*Carefully remove the new lamp assembly from the box. Insert lamps into lamp holder. Make sure bulbs are aligned and seated correctly.

Step 7

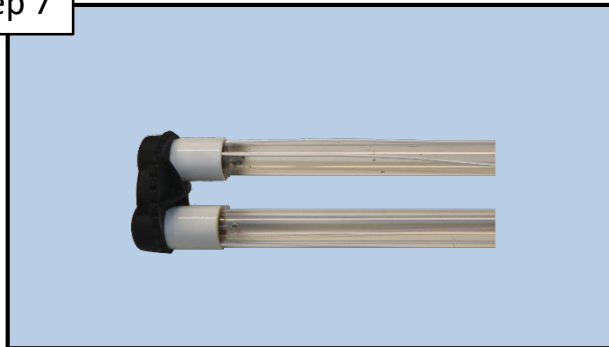

Gently insert lamps into lower lamp boot.

Step 8

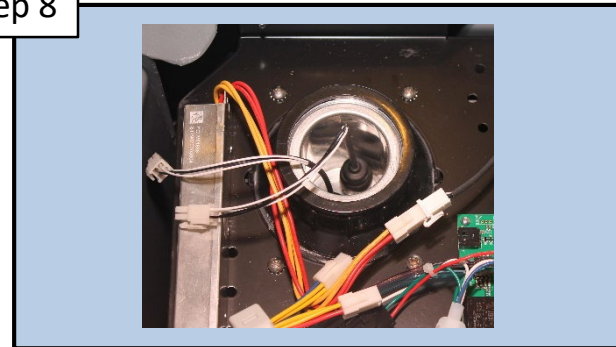

Carefully lower the lamp assembly into the unit.

Maintenance: Replace UV Lamps (cont.)

Step 9



Re-install the spring clip and re-connect the lamp cables.

Step 10

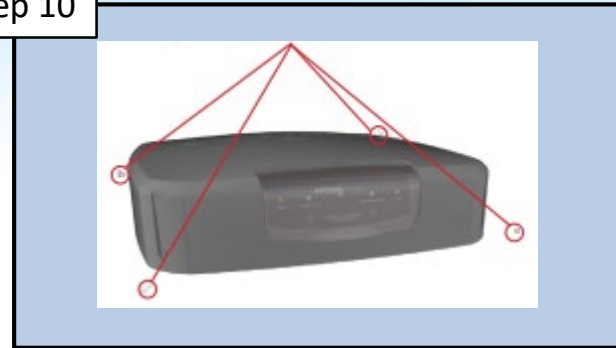

Re-install the electrical cover and Lid cover onto the unit and secure the four (4) screws.

Step 11

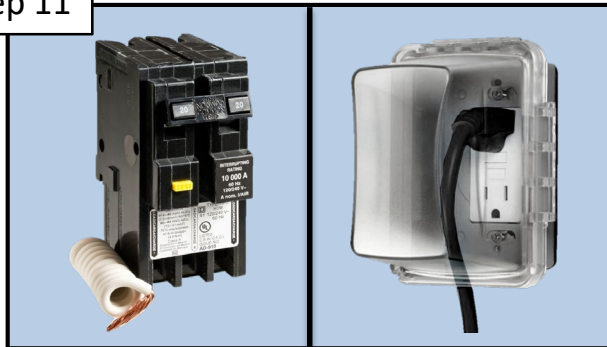

Re-connect power to the unit and pool equipment.

Step 12

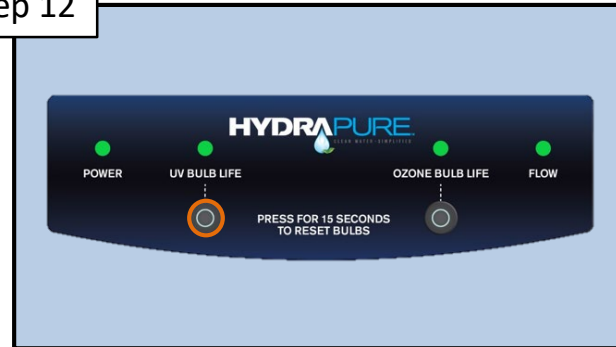

Hold down the UV Bulb Life button for 15 seconds to reset the lamp life counter.

Maintenance: Replace O3 Lamp

Step 1

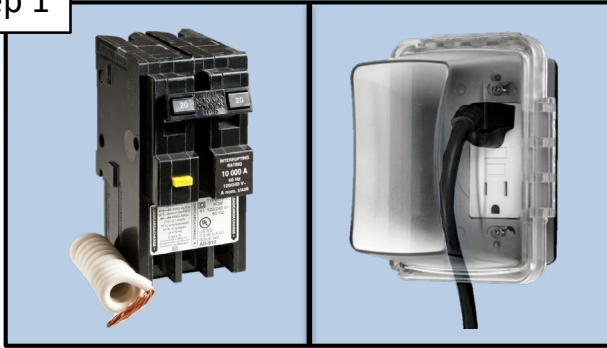

Turn off/unplug all power to the HydraPure and all other pool equipment. Allow unit to cool for 15 minutes before proceeding to the next step.

Step 2

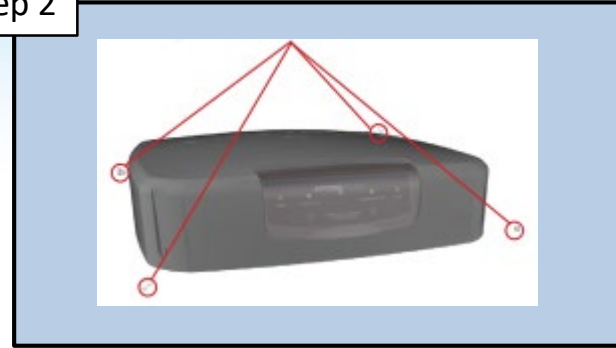

Remove the four (4) screws that secure the Lid cover. Use the provided strain relief to allow cover to hang to the side.

Step 3



Remove the one (1) screw that secures the electrical enclosure cover, remove the cover and set it to the side.

Step 4

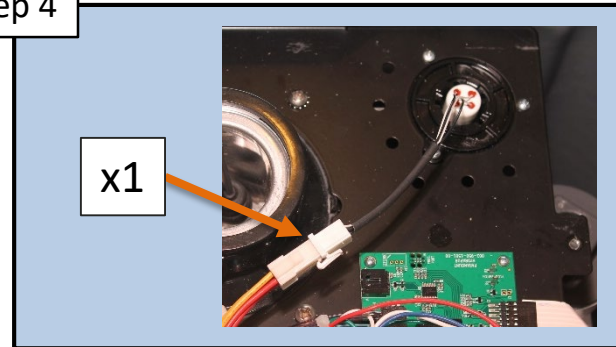

*Wearing protective rubber gloves and safety eyewear, disconnect the lamp by pressing the release tab and gently pulling apart.

Maintenance: Replace O3 Lamp (cont.)

Step 5

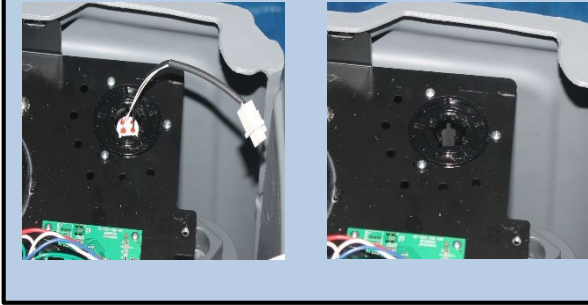

Carefully lift the lamp assembly. A slight tug may be needed to jostle the lamp loose from the lamp retention fingers.

Step 6

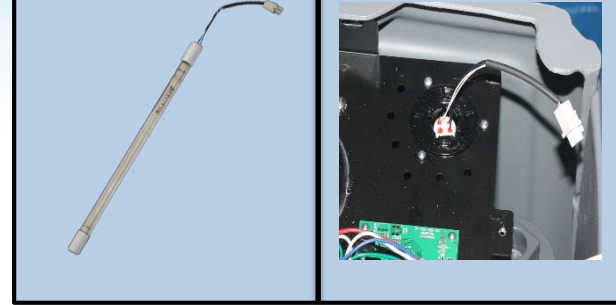

Carefully remove new lamp from the box and insert it into the lamp holder. Make sure lamp is aligned and seated properly.

Step 7

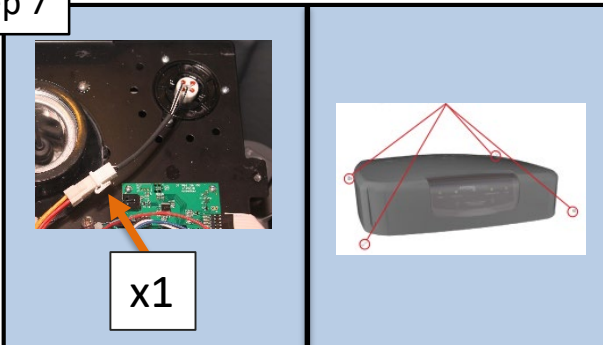

Re-install the lamp connectors to the ballast. The lamp connector can only be installed one way. Re-install electrical and Lid cover.

Step 8



Apply power to pool equipment and hold down OZONE Bulb Life button for 15 seconds to reset the lamp life counter.

Maintenance: Winterize HydraPure

Step 1

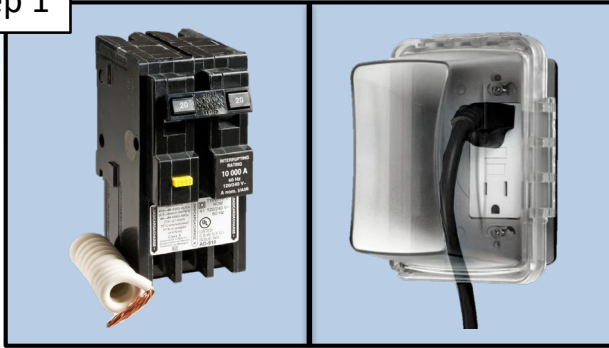

Turn off/unplug all power to the HydraPure and all other pool equipment. Make sure the pump will not re-activate.

Step 2



Remove the winterizing drain plug near the bottom of the unit. There will be an initial rush of water once plug is removed.

Step 3

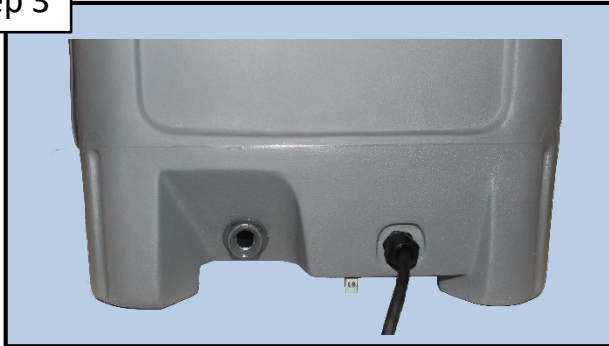

Allow unit to completely drain. This process can take up to two (2) minutes.

Step 4



Once vessel is drained, re-install the drain plug hand tight only. Do NOT lose the plug O-ring.



HYDRAPURE
CLEAN WATER · SIMPLIFIED

Troubleshooting Guide



Troubleshooting: Power and Flow LED's



| LED | Status | Description |
|-------|--------|---|
| Power | Green | The unit is receiving power correctly. Note: this light is always on when power is connected. |
| Power | Off | The unit is not connected to power. If unit is connected to power check the ribbon cable connections. |
| Flow | Green | This indicates the flow sensing of the unit has activated. This is indication the flow sensing is working properly. This light will only light when proper flow is being applied to the unit. |
| Flow | Off | This indicated the unit is not sensing proper flow. This will be typical when the pump is shut off. |

***To reset unit cycle power off and back on.**

Troubleshooting: Power LED Off

Step 1A



If Power LED is not illuminated, the unit typically does not have power applied to it.

Step 1B

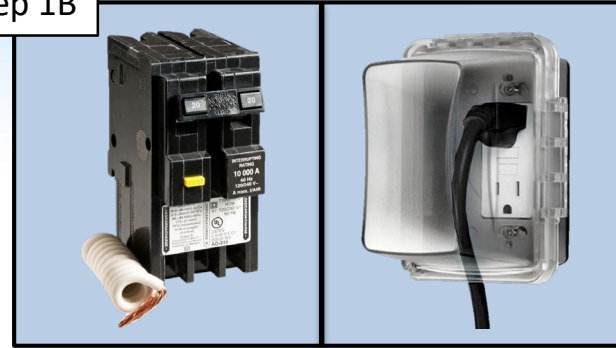

Verify the breaker is turned ON and/or the unit is plugged into the G.F.C.I. receptacle.

Step 1C

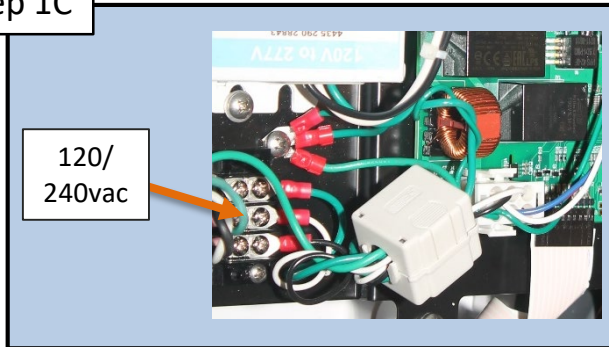

Test applied voltage at the circuit board. If voltage is present, go to step 1D. If not, inspect wiring connections.

Step 1D

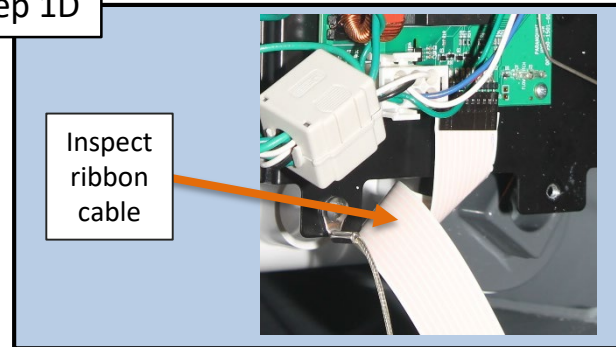

*Verify the display ribbon cable is plugged in and free of damage. If damage is found replace ribbon cable & keypad. If not, replace the PCB.

***The cable must be fully inserted and clipped into the membrane switch and control board. Keys should be facing up at the control board connection.**

Troubleshooting: Flow LED Off

Step 2A



Flow LED off typically indicates that the unit is not properly sensing water flow. Verify filter and strainer basket(s) are clean. Go to Step 2B

Step 2B

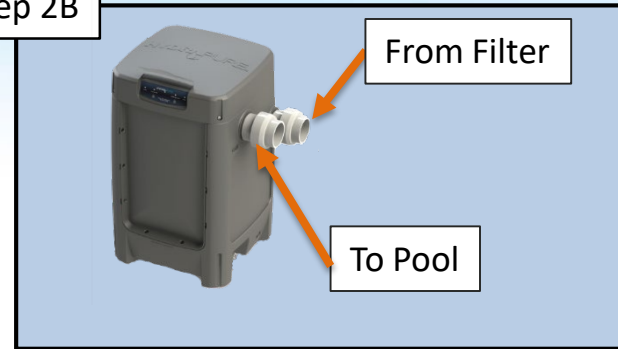

Verify pump is on and moving a min of 20 gallons per minute (gpm). Verify unit is plumbed correctly. Go to Step 2C.

Step 2C

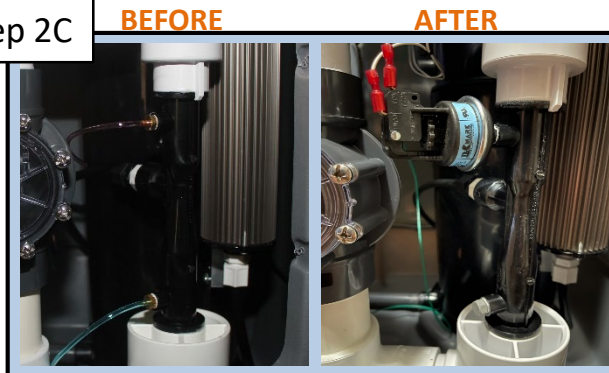

Verify the age of the unit. For serial numbers before 3X21153-8045543 go to Step 2D, for units after go to Step 2I

Step 2D

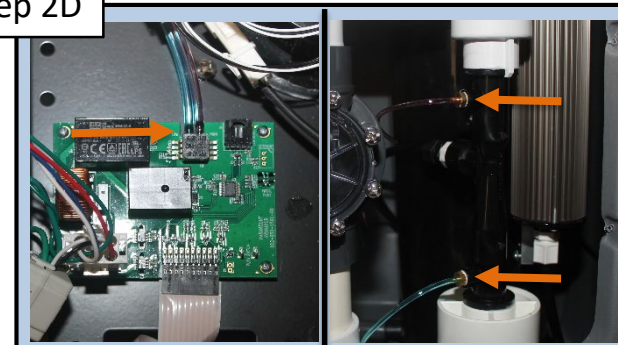

Verify the flow tubes are connected and free of damage. Replace if needed. Go to step 2E.

Troubleshooting: Flow LED Off

Step 2E

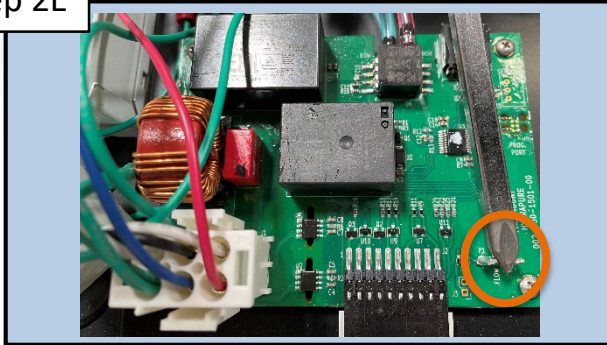

Using a metallic jumper, jump the 2 male pins shown above on PCB board. This bypasses the differential pressure sensor. Go to step 2F

Step 2F



If the unit came on, install Pressure switch kit Part #005-952-1501-00 (steps on page 35) - if unit did not come on go to step 2G

Step 2G

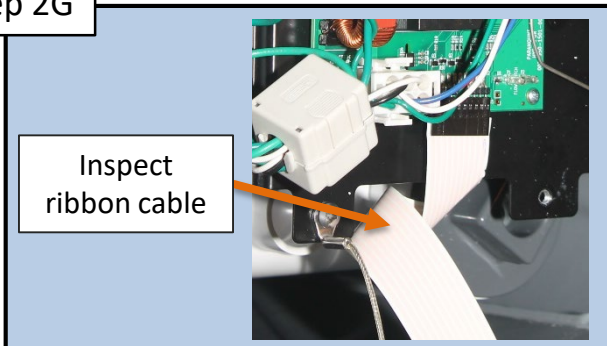

Verify the display ribbon cable is plugged in and free of damage. If damage is found replace ribbon cable & keypad. Go to Step 2G.

Step 2H

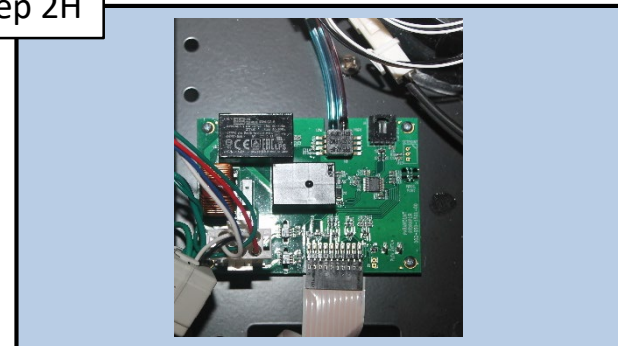

If everything else has checked out and unit still does not register flow, replace the PCB.

Troubleshooting: Flow LED Off

Step 2I

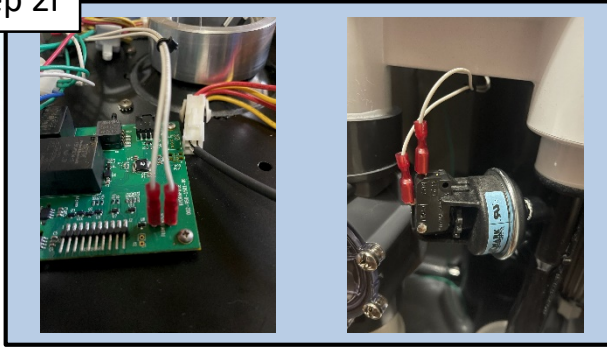

Inspect the water pressure switch wiring, ensuring wire harness terminals are securely fastened. IF damaged, replace wire harness. IF secure and free of damage, go to step 2J.

Step 2J

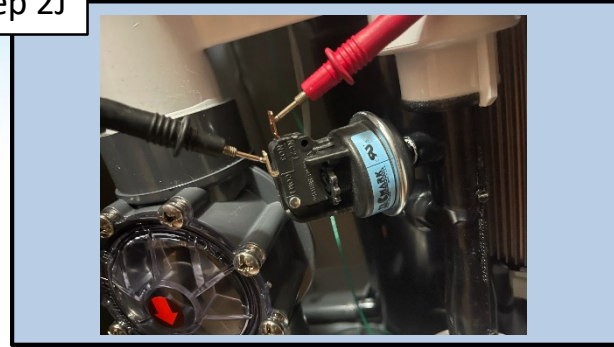

Remove wires from water pressure switch & measure continuity across terminals (while pump is running). If open, replace water pressure switch. If closed, go to Step 2K.

Step 2K

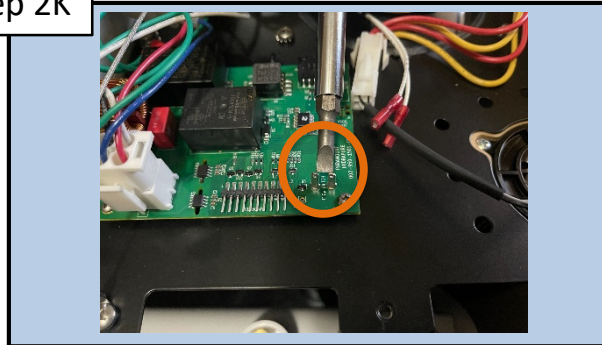

Using a metallic jumper, jump the 2 male pins shown above on PCB board. Unit will come on. Verify that all lamps are lit, if not go to Step 2G

How To: Install New Style Pressure Switch

Step 1

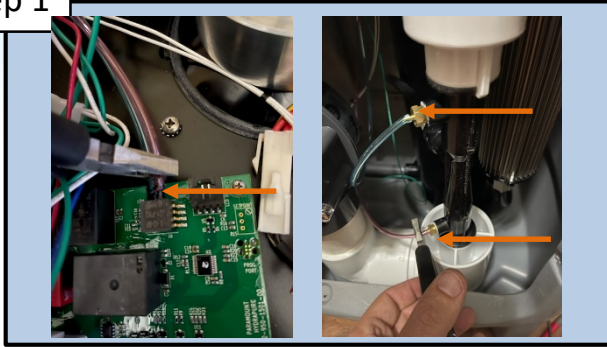

Cut the Red and Blue tubing off of the venturi injector and off of the PCB and discard. Proceed to step 2

DO NOT PULL THE TUBING OFF OF THE PCB BOARD OR THE BARBED FITTINGS

Step 2

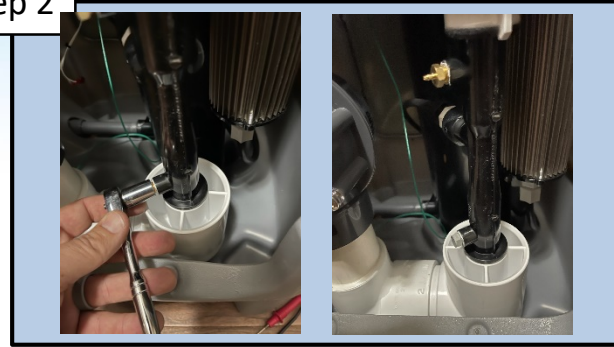

Using a 7/16 socket, remove the lower barb fitting. Use approved thread sealant and install the supplied 1/4" NPT plug. Go to step 3

Step 3

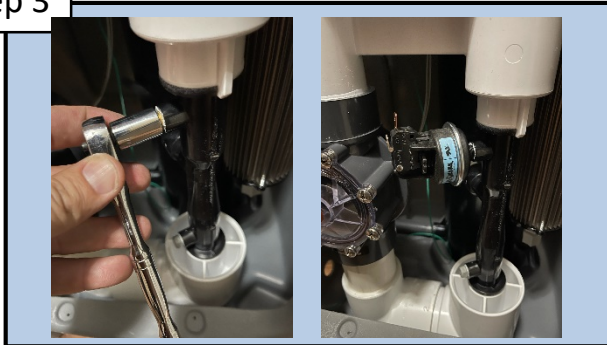

Using a 7/16 socket, remove the upper barb fitting. Use approved thread sealant and install the pressure switch. Go to step 4

Step 4

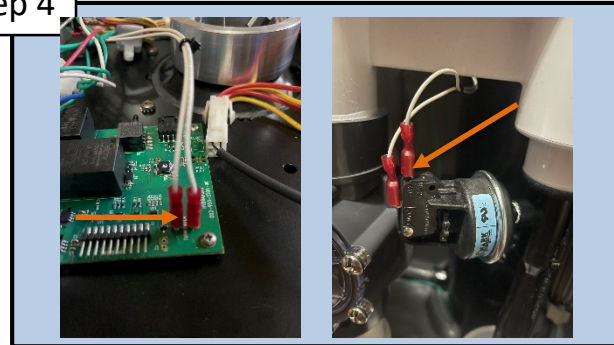

Route wires through the rubber grommet and install on the PCB board labeled Flow Switch, and install the other end to pressure switch.

Troubleshooting: UV Bulb Life LED



| LED | Status | Description |
|--------------|--------------------|---|
| UV Bulb Life | Green | This indicates the UV system lamps are on and functioning correctly. |
| UV Bulb Life | Off | The UV lamps are not on, and should not be. |
| UV Bulb Life | Flashing Red/Green | Indicates the UV lamps need to be replaced. This is a good time to order replacement lamps. |
| UV Bulb Life | Flashing Red | Indicates the UV lamps are at a critical Life Level and the unit is no longer producing sanitization. |
| UV Bulb Life | Red | The UV lamps are not properly lit, and should be. There is a problem with the UV lamps. |

***To reset unit cycle power off and back on.**

Troubleshooting: UV Bulb Life LED (cont.)

Step 3A

LED off



When no flow is detected, LED and bulb should be off. They will remain off until flow has been detected.

Step 3B

LED flashing red/green



Bulbs are functioning properly, but is nearing the end of their life expectancy. Order replacement bulbs at this time.

Step 3C

LED flashing red/off



Bulbs have reached critical life level and **MUST** be replaced.

Step 3D

LED solid red



Bulbs should be on and are not. Flow Led should be on at this time. Move to step 3E.

Troubleshooting: UV Bulb LED Solid Red (cont.)

Step 3E

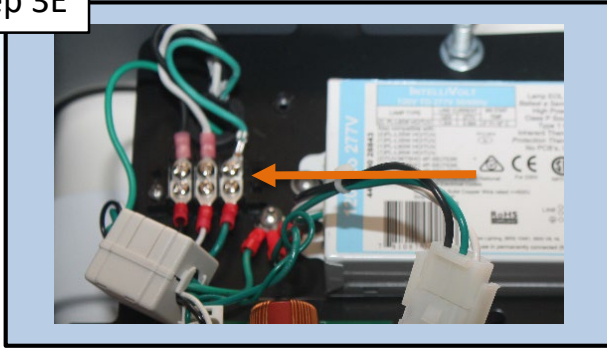

Verify input voltage is within 10% nominal voltage. Correct if necessary. Go to step 3F.

Step 3F



Check voltage at UV ballast input for 120V. If voltage is correct go to step 3G. If not replace PCB.

Step 3G



Verify UV Bulb plugs are securely connected. Go to step 3H.

Step 3H

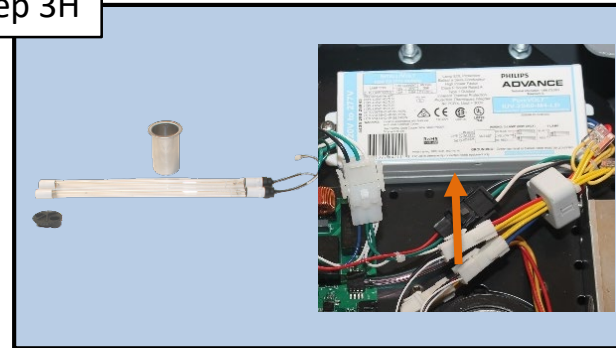

Replace UV Bulbs. If still no light then replace the UV Bulb lamp ballast.

Troubleshooting: Ozone Bulb Life LED



| LED | Status | Description |
|-----------------|--------------------|---|
| Ozone Bulb Life | Green | This indicates the Ozone system lamp is on and functioning correctly. |
| Ozone Bulb Life | Off | The Ozone lamp not on, and should not be. |
| Ozone Bulb Life | Flashing Red/Green | Indicates the Ozone lamp needs to be replaced. This is a good time to order a replacement lamp. |
| Ozone Bulb Life | Flashing Red | Indicates the Ozone lamp is at a critical Life Level and the unit is no longer producing Ozone. |
| Ozone Bulb Life | Red | The Ozone lamp is not functioning properly, and should be. There is a problem with the Ozone lamp. See troubleshooting section. |

***To reset unit cycle power off and back on.**

Troubleshooting: Ozone Bulb Life LED (cont.)

Step 4A

LED off



When no flow is detected, LED and bulb should be off. They will remain off until flow has been detected.

Step 4B

LED flashing red/green



Bulb is functioning properly, but is nearing the end of its life expectancy. Order a replacement bulb at this time.

Step 4C

LED flashing red/off



Bulb has reached critical life level and **MUST** be replaced.

Step 4D

LED solid red



Bulb should be on and is not. Inspect bulb and replace if necessary. If ok, go to step 4E.

Troubleshooting: Ozone Bulb LED Solid Red (cont.)

Step 4E

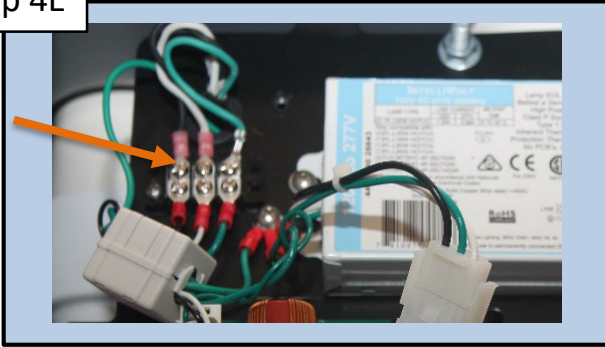

Verify input voltage is within 10% nominal voltage. Correct if necessary. Go to step 4F.

Step 4F



Check voltage at black Ozone ballast input for 120V. If correct go to step 4G. If not, replace PCB.

Step 4G

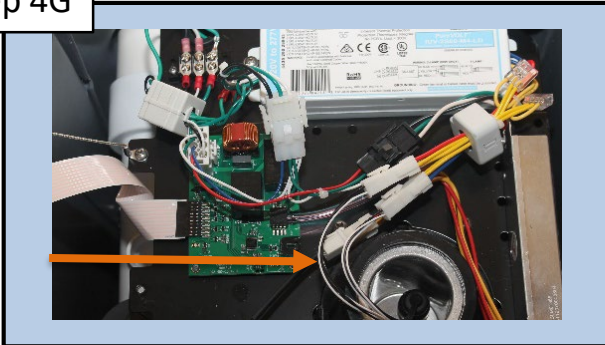

Verify Ozone Bulb plugs are securely connected. Go to step 4H.

Step 4H

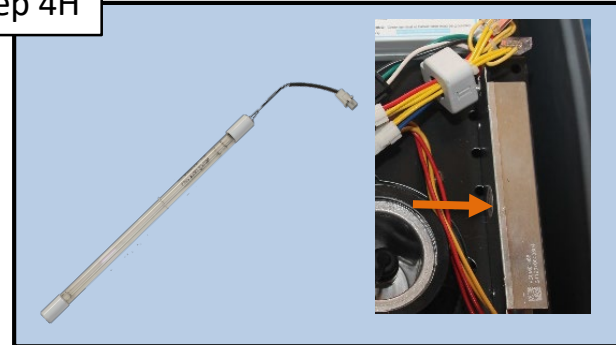

Replace Ozone lamp. If still no light then replace the Ozone lamp ballast.



HYDRAPURE
CLEAN WATER · SIMPLIFIED

Parts Breakdown



Parts Breakdown: Exploded View

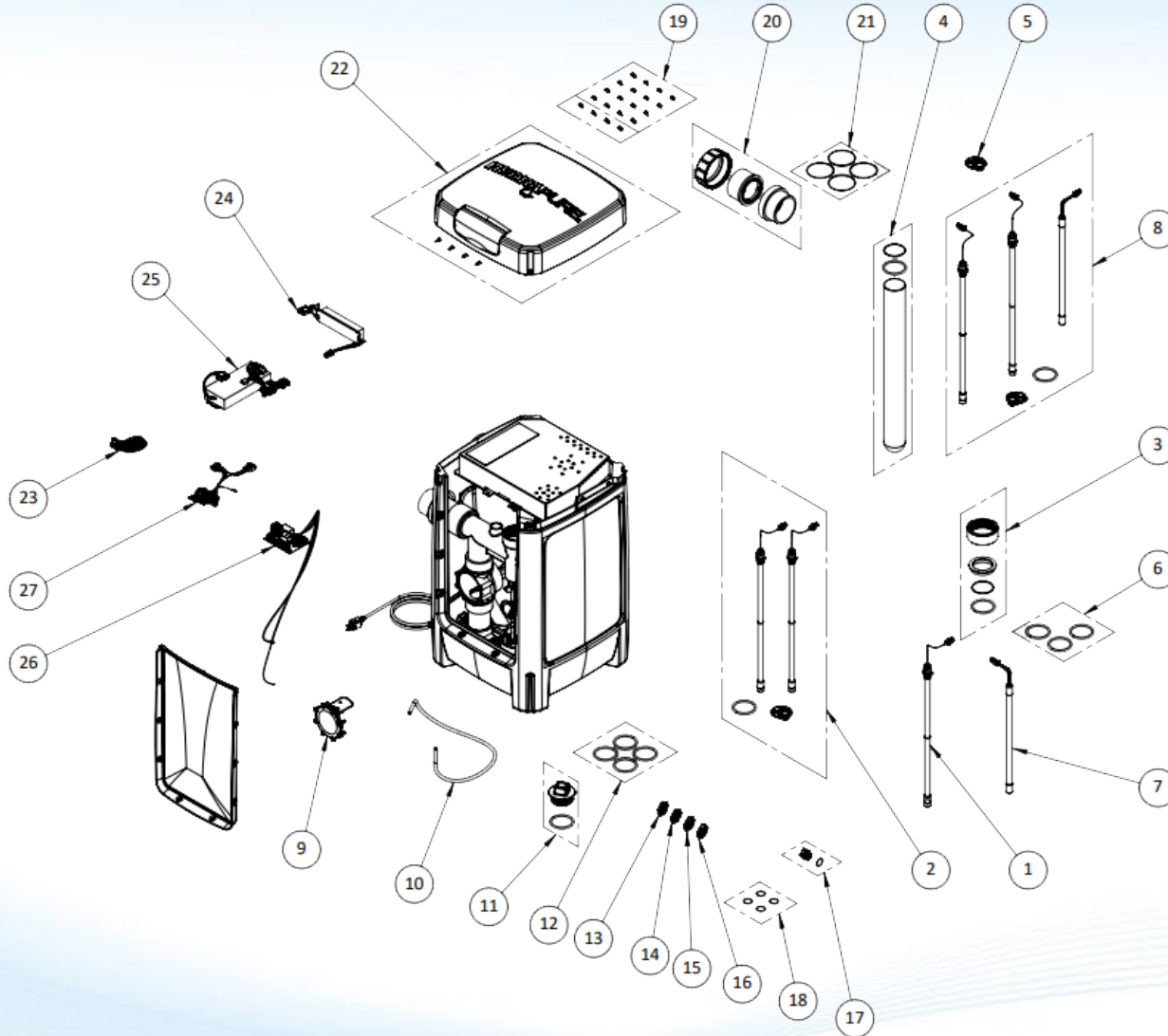

Parts Breakdown: **Parts List**

| Ref # | Part # | Description |
|-------|--------------|--|
| 1 | 005422901700 | Lamp UV/Hydra 1pc |
| 2 | 005422901500 | Lamp UV/Hydra 2pc w/Boot & O-ring |
| 3 | 005422510200 | Nut & Washer UV/Hydra |
| 4 | 005422200909 | Quartz Tube w/ O-ring & Cushion |
| 5 | 005422427100 | Boot F/2Lamp |
| 6 | 005422510300 | Seal Kit Quartz Tube |
| 7 | 005952123000 | Lamp Only 1pc Hydra/O3 |
| 8 | 005952902400 | Lamp Kit 3pc w/Boot & O-ring, UV & O3 |
| 9 | 005252829000 | Check Valve Swing 5lb w/Springs, No Body |
| 10 | 005952125000 | Tubing 3/8x24 Flexelene |
| 11 | 005252164000 | Plug 2" w/O-ring |
| 12 | 005252016000 | O-ring -331 EPDM 70 F/Plug 2" 4pk |
| 13 | 005402250500 | Check Valve 1lb 1/4NPT x 3/8COMP |
| 14 | 005402250600 | Check Valve 2lb 1/4NPT x 3/8COMP |

Parts Breakdown: **Parts List (cont.)**

| Ref # | Part # | Description |
|-------|--------------|------------------------------------|
| 15 | 005401250300 | Check Valve 3lb 1/4NPT x 3/8COMP |
| 16 | 005401250400 | Check Valve 4lb 1/4NPT x 3/8COMP |
| 17 | 005952291500 | Plug Drain ½" w/O-ring |
| 18 | 005952291700 | O-ring F/Drain Plug 1/2" 4pk |
| 19 | 005952832500 | Screw Panel/Lid 16+4pk |
| 20 | 005252832000 | Union 2.5 Kit (1pc) w/O-ring |
| 21 | 005252831500 | O-ring 2-232 F/2.5" Union 4pk |
| 22 | 005952140100 | Lid Top w/Membrane Switch & Screws |
| 23 | 005952147100 | Cable Ribbon F/Membrane Switch |
| 24 | 005952157000 | Ballast w/Wires, Ozone |
| 25 | 005422386500 | Ballast w/Wires, UV |
| 26 | 005952150100 | Board w/Tubes & Sensor |
| 27 | 005952158100 | Wire Harness |